

Sheet 1007 x 505mm
 90 Deg Bends Inside
 11
 $292.5+11$
 $400+292.5+11$
 $292.5+400+292.6+11$
 $11+292.5+400+292.5+11$

Outside dimensions

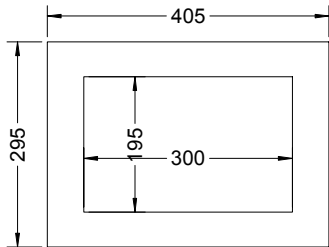

Door Frame

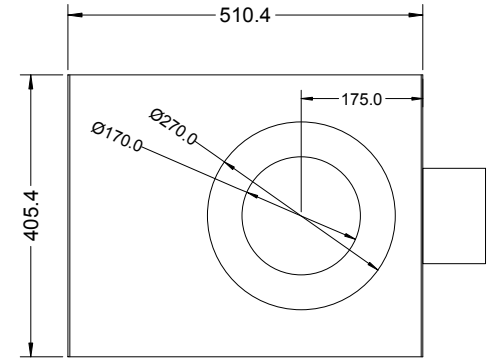
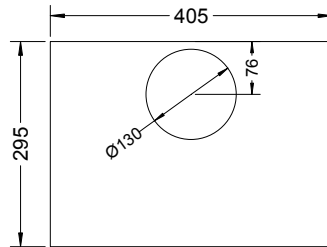

End Plate

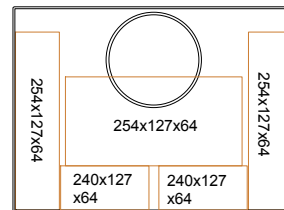

Cooking hole supports rings
 Material 2mm mild steel

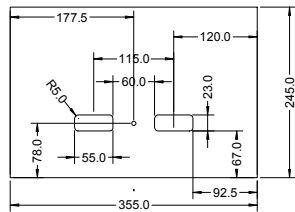
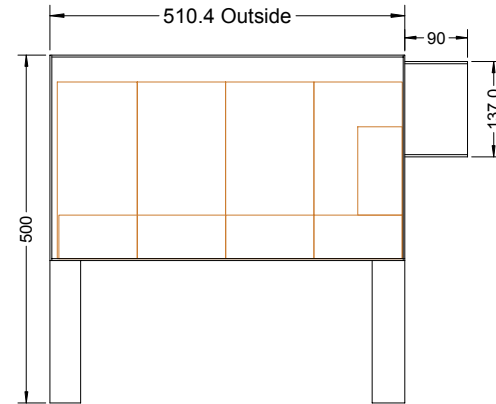
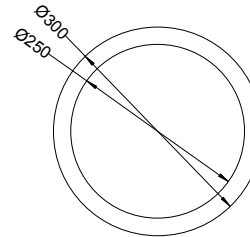

Door

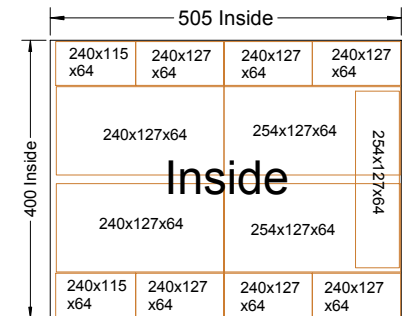
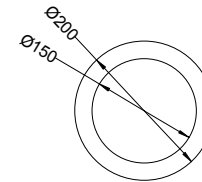
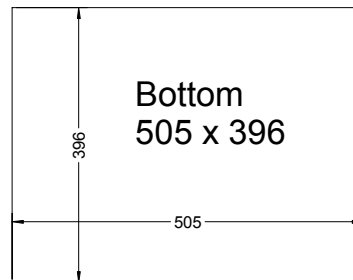

2030